







Linea ELAP 15



(CORD-R+FLAP15+ELAP15)

-  Linea automatica per cordonare, applicare 2 patelle laterali e fissare una banda elastica piatta larga 15 mm
-  Automatic line for creasing folders, automatically riveting 2 side flaps and fastening one flat elastic band 15 mm wide
-  Ligne automatique pour réaliser des rainages, poser 2 rabats latéraux et fixer une bande élastique plate large 15 mm
-  用来折边，固定两个侧面活页和宽15毫米的松紧带的自动化生产线

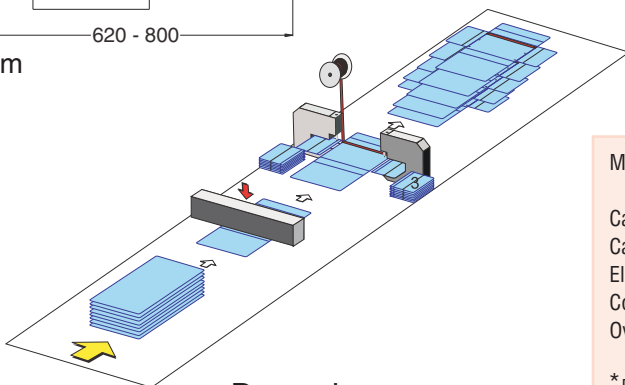
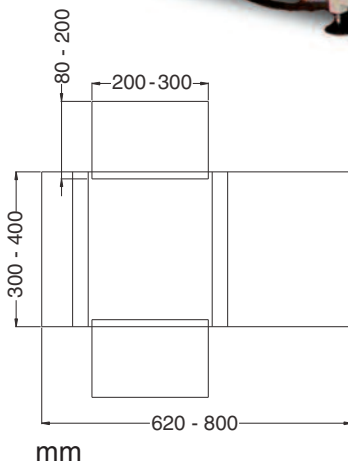
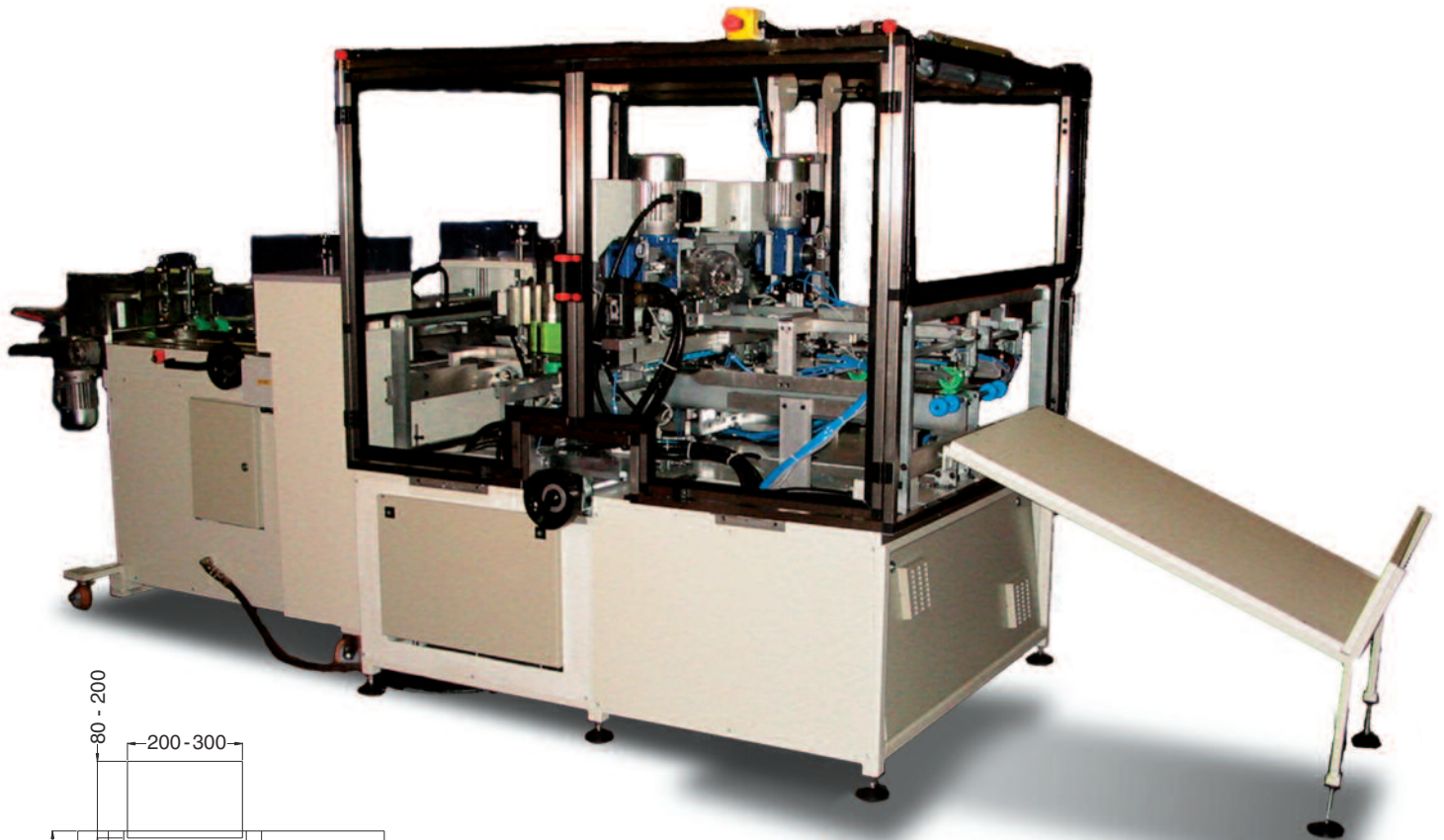

Dynamic process

Materials: Coated board, Fiber board or similar, Rivets with cap or Auto-punching eyelets, Elastic band 15 mm wide

Cardboard thickness: 1 mm to 2,5 mm

Capacity: up to 18 cycles/minute (with 2 rivets/eyelets per flap)*

Electrical power req.: 3,7 Kw

Compressed air: 200 NL/min. (pressure 7 bar)

Overall dimensions: L=4800mm W=1500mm H=2000mm

* Production capacity of every machine depends on sizes, type of materials, glues and operator skill. Peroni's policy is one of continual product improvement and we can reserve the right to alter design and/or specifications without notice